

FlexiPanels® Advance HMI FP4 Series

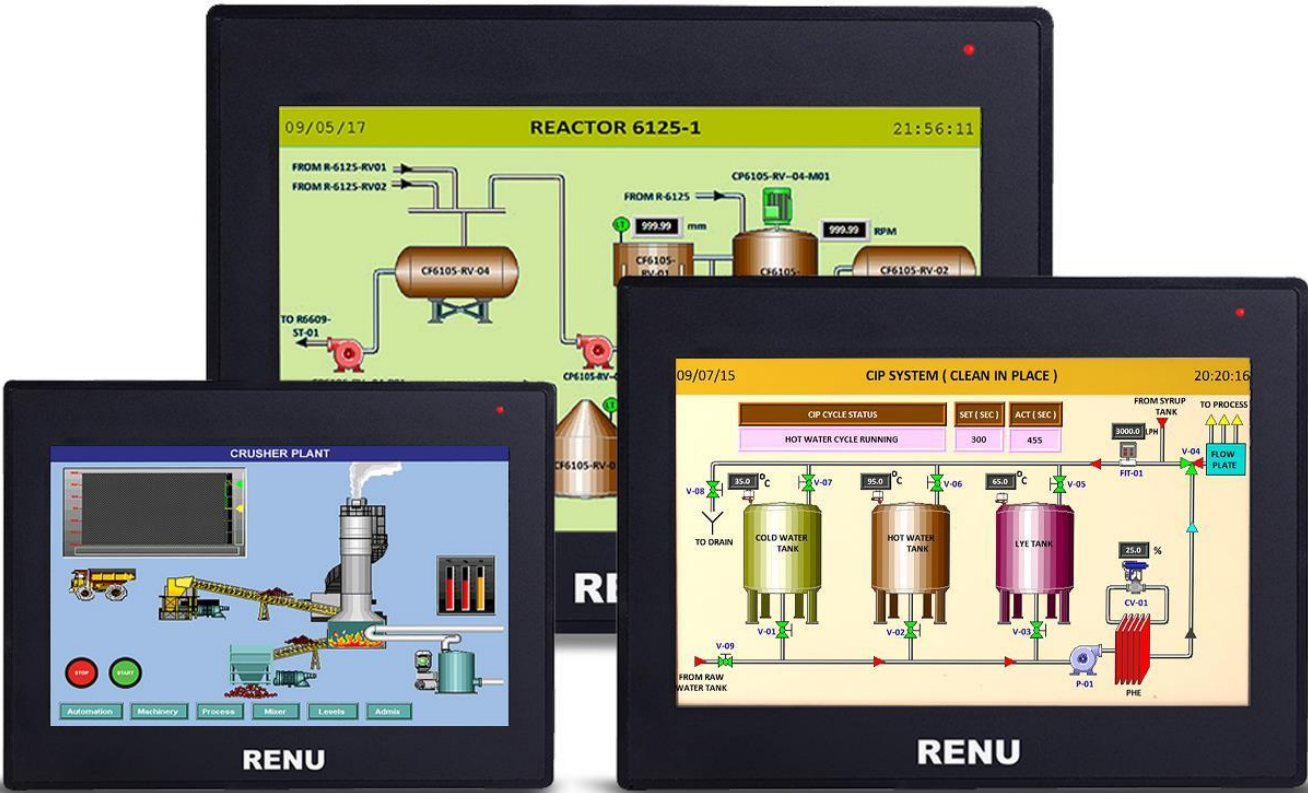

Table of Contents

INTRODUCTION	3
BEFORE YOU START.....	3
SAFETY PRECAUTIONS.....	4
PRODUCT OVERVIEW	5
INSTALLING FP4 PRODUCTS	5
PANEL GUIDELINES	5
PANEL CUTOUT DIMENSIONS	5
PRODUCT DIMENSIONS	5
MINIMUM CLEARANCES	7
MOUNTING FP4 PRODUCTS.....	7
CONNECTING POWER.....	7
GROUNDING	7
PRODUCT SPECIFICATIONS	8
PRODUCT NOMENCLATURE / ORDERING PART NUMBER	8
DISPLAY SPECIFICATIONS.....	8
CPU, MEMORY AND POWER SUPPLY.....	9
COMMUNICATION INTERFACES	10
RS232 / RS422 / RS485 PORT	10
ETHERNET PORT	12
USB DEVICE PORT	12
USB HOST PORT	12
Y TYPE CABLE.....	13
SD CARD SLOT	13
ACCESSORIES	14
PROGRAMMING CABLE	14
COMMUNICATION CABLE.....	14
ENVIRONMENTAL SPECIFICATIONS AND APPROVALS	15
REVISION HISTORY.....	16
NOTES	17

Introduction



FP4 Advance HMI series is a powerful, feature rich and versatile HMI product range with a complete range of screen size starting with compact 4.3" WQVGA TFT color display, covering most popular screen sizes in the industry (7", 10.1", 12.1"), till dynamic 15" XGA TFT color screen. These HMIs are powered by FlexiSoft® programming software and supports a powerful FlexiSoft® runtime for efficient performance. IEC61131-3 logic programming environment support give a unique edge to these products.

All the products are compliant to EMC directive 2014/30/EU and LVD directive 2014/35/EU and suitable for installation in hazardous locations, because they are listed for UL Class I Div. 2.

This user manual gives detailed information regarding the hardware specifications, operating conditions, installation, mounting and wiring. All the information published in this manual is produced and governed by Renu Electronics Pvt. Ltd. and is protected by Indian Copyright Act.

Before you start

- FlexiPanels® FP4 series products are general purpose human machine interface devices, suitable for a variety of industrial applications across various industries. However, Renu Electronics is not responsible or liable for any indirect or consequential damage resulting from the use of this product.
- The user should check and confirm the suitability of the product before using in any specific application.
- The diagrams and examples in this manual are included for illustration purpose only. Renu Electronics assume no responsibility or liability regarding actual use based on these diagrams or examples.
- Reproduction of the contents of this manual, in any form (in part or in whole), is strictly prohibited.
- Following table shows various symbols that may be used in this manual to provide information regarding safety, precautions and usage of the product:

	WARNING: Indicates circumstances that may cause an explosion in hazardous environment, which may lead to injury or death, damage or economic loss
	CAUTION: Indicates specific precautions to be taken by user during installation, operation and maintenance of the product
ATTENTION	ATTENTION: Indicates important information regarding application and functions of the product

Safety Precautions

This section of the manual provides information which is critical regarding safety and therefore the user is advised to go through the information in detail before installing the product. User may contact Renu Electronics technical support team at support@renuelectronics.com for any specific question(s) related to safety.



WARNING: EXPLOSION HAZARD

- Do not disconnect equipment unless power has been removed or the area is known to be nonhazardous.
 - Substitution of any component may impair suitability for Class I, Division 2.
 - Secure any external connections that mate to this equipment by using screws, sliding latches, threaded connectors or any other means provided with this product.
 - If this product contains batteries, they must only be changed in an area known to be nonhazardous.
-



CAUTION: GENERAL PRECAUTIONS

- Do not use this product for emergency stop. A separate physical switch, outside the product must be used for any emergency stop operations.
 - Do not use the external power supply source that does not comply with the specified power requirements of the product, it may cause malfunction or permanent damage to the product.
 - Do not attempt to open, dismantle or modify the product, doing so will void the warranty.
 - This product is supplied as open-type equipment and it must be mounted within an enclosure, suitably designed for specific environmental conditions.
 - When used in Class I, Division 2 hazardous location, the product must be mounted in a suitable enclosure with proper wiring method that complies with the governing electrical codes.
 - The USB port is intended for temporary local programming purpose only and not intended for permanent connection. If you connect or disconnect the USB cable with power applied to this product or any other device on USB network, and electrical arc can occur, which could cause explosion in hazardous location installations.
 - Make sure that connectors are securely tightened to properly seal the connections against leaks.
 - Do not place the product in direct sunlight. Prolonged exposure to sunlight may degrade the LCD and housing.
-

Product Overview

This section of the manual provides an overview of FP4 series products, its front and back view, installation details, dimensional details, mounting method and details.

Installing FP4 products

FP4 series products are designed for front panel mounting. Before installing the products, user should review the panel guidelines, panel cutout dimensions, product dimensions and minimum clearances.

Panel Guidelines

The panel must be at least 2 mm (12 gauge), so that it can provide the required support and proper sealing against water and dust. The panel surface must be flat, without any imperfection, to maintain adequate seal and IP rating.

Maximum panel thickness allowed is 6 mm (± 0.2 mm).

Panel Cutout Dimensions

The panel must be at least 2 mm (12 gauge), so that it can provide the required support and proper sealing against.

Model	Height (mm)	Width (mm)
FP4043T	111	80
FP4043TN	111	80
FP4070T	175	127
FP4070TN	175	127
FP4101T	256	178
FP4101TN	256	178
FP4121T	293	225
FP4121TN	293	225
FP4150T	386	285
FP4150TN	386	285

ATTENTION ATTENTION: Panel cutout

- Before making panel cutout, disconnect all electrical power from the panel.
- Make sure that area surrounding the panel cutout is clear.
- Make sure that metal cutting does not enter any component already installed in the panel.

Product Dimensions

This section of the manual provides dimensional details of FP4 series products. All the dimensions shown below are measured in mm.

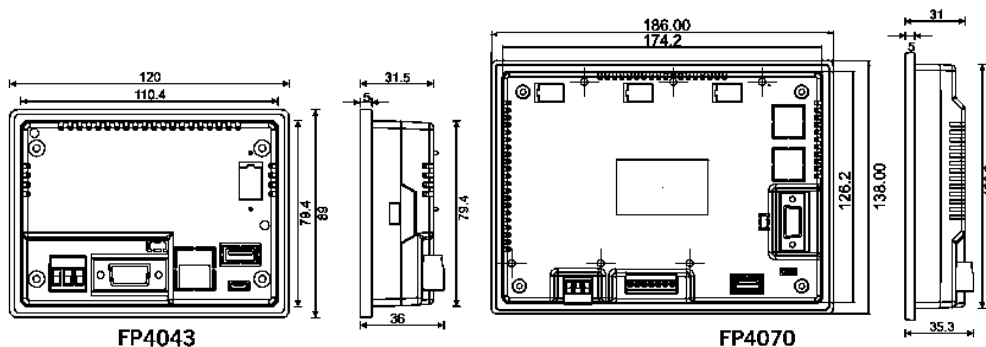

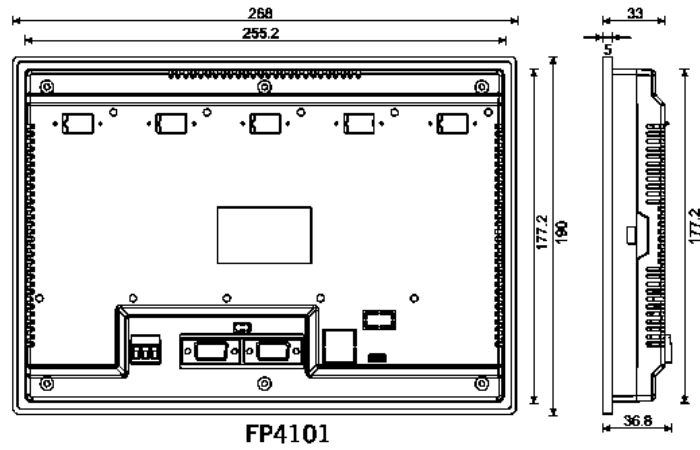

FP4101

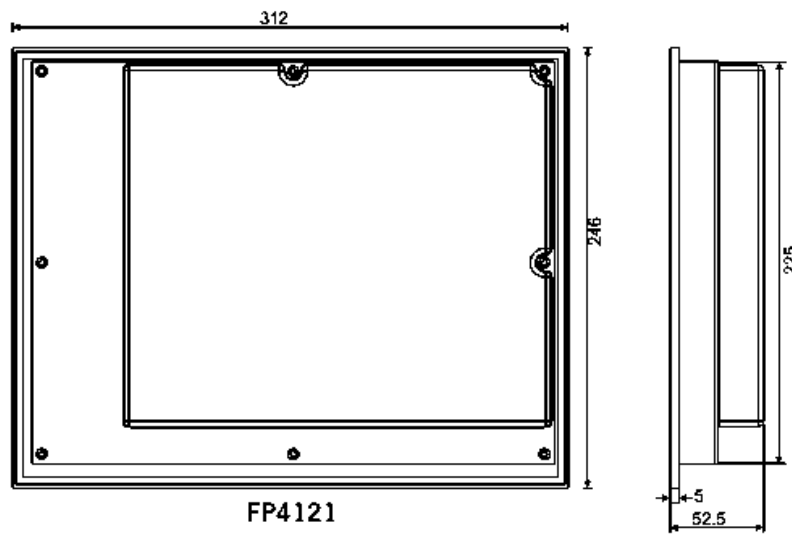

FP4121

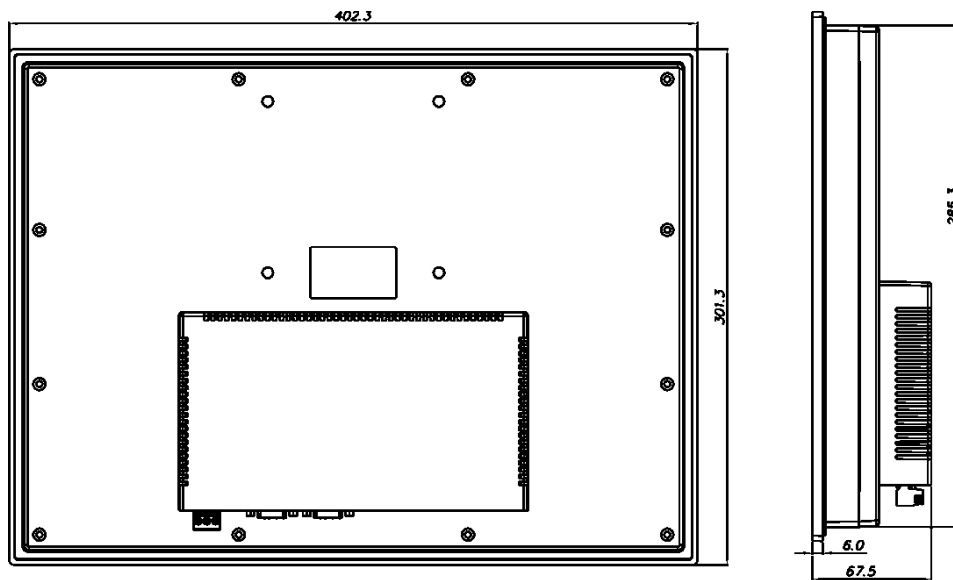

FP4150

Minimum Clearances

Maintain clearance from enclosure walls, wires and other adjacent devices. Keep 2" space on all sides for adequate ventilation. Plan for adequate space around the product and inside the enclosure for ventilation and cabling. Take into consideration the heat produced by other devices in the enclosure. The ambient temperature around this product must be -10° to 60° C.

Mounting FP4 Products

FP4 series products must be installed on the front panel, using the clamp accessories shipped with the product. Before mounting, make sure that sealing gasket is properly positioned. This gasket forms a compression type seal. Do not use sealing compounds. Then, place the unit in the panel cutout and tighten the mounting screws evenly (torque 0.4 Nm) to maintain water and dust resistance.

ATTENTION **ATTENTION: Mounting FP4 on Panel**

- Do not push LCD display when pushing the unit into the panel as it may damage the display.
-

Connecting Power

FP4 series require 24 VDC power supply. Follow the steps mentioned below to connect the power:

- Make sure that terminal is not connected to power source
- Secure the 24 VDC power wires
- Secure the functional earth ground wire to the functional earth ground terminal screw on terminal block
- Apply 24 VDC power to the terminal

Grounding

The optimum method for grounding electronic equipment is to ground it separately from other high-power systems and to ground more than one unit of electronic equipment with a single-point ground. Following marked terminal is provided with the unit for grounding:

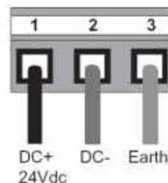

Product Specifications

This section of the manual provides detail specifications of FP4 series products, ordering part numbers, operating conditions, environment and approvals.

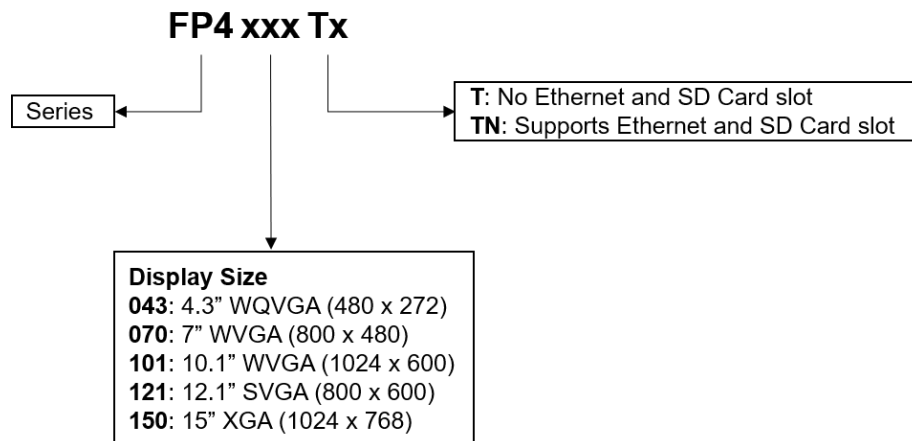

Product Nomenclature / Ordering Part Number

FP4 series has 5 models, depending on display size and each model has two variants, based on Ethernet and SD Card slot support. Detail part number or ordering information is as follows:





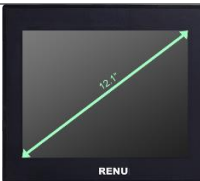
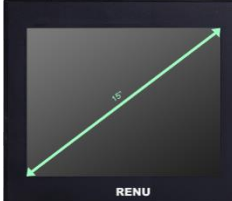

Display Specifications

FP4 series products support high quality color TFT display range.

	<p>Size: 4.3" WQVGA color TFT with 4-wire analog resistive touch screen Resolution: 480 x 272 pixels Brightness: 400 cd/m² Backlight life: 30,000 Hrs.</p>
	<p>Size: 7" WVGA color TFT with 4-wire analog resistive touch screen Resolution: 800 x 480 pixels Brightness: 350 cd/m² Backlight life: 30,000 Hrs.</p>
	<p>Size: 10.1" WVGA color TFT with 4-wire analog resistive touch screen Resolution: 1024 x 600 pixels Brightness: 350 cd/m² Backlight life: 50,000 Hrs.</p>
	<p>Size: 12.1" SVGA color TFT with 4-wire analog resistive touch screen Resolution: 800 x 600 pixels Brightness: 500 cd/m² Backlight life: 70,000 Hrs.</p>
	<p>Size: 15" XGA color TFT with 4-wire analog resistive touch screen Resolution: 1024 x 768 pixels Brightness: 400 cd/m² Backlight life: 50,000 Hrs.</p>

CPU, Memory and Power Supply

	CPU: 32-bit RISC processor
	eMMC: 4GB
	RAM: 512MB
User Application	Up to 1 GB that includes user application, data log, alarms, retentive memory and logic memory

	Power Supply: 24 VDC ($\pm 15\%$) with isolation
	RTC: Built-in, date and time function

ATTENTION

ATTENTION: Logging to External memory

- The Ethernet models of FP4 series supports SD card slot, which can be used to log the data directly on SD card. MicroSD HC card with capacity between 4 GB to 32 GB is supported. Supported speed classes are as follows:



- While inserting or removing SD card, the device power must be turned off.
- The user must take periodic backup of logged data to avoid loss of data.

Communication Interfaces

This section of the manual gives detail information regarding various communication interfaces supported by FP4 series products, including communication interfaces between FP4 and other RENU or any third-party device, interfaces for programming and monitoring.

RS232 / RS422 / RS485 Port

FP4 products support DB9 female port for RS232 / RS422 / RS485 communication. 4.3" and 7" models support one DB9 female port and 10.1", 12.1" and 15" models support two DB9 female ports.

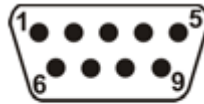

DB9 pin connector

Pin number	Signal
1	TX+(RS422/RS485)
2	TXD(RS232)
3	RXD(RS232)
4	RX+(RS422/RS485)
5	GND
6	NC
7	NC
8	TX-(RS422/RS485)
9	RX-(RS422/RS485)

7" model support one terminal block port (COM 1).

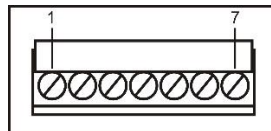

Pin number	Signal
1	RX-
2	TX-
3	RX+
4	TX+
5	GND
6	RXD
7	TXD

RS232 MALE

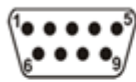

RS232 pinout

RS232 FEMALE

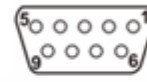

Pin number	Signal	Pin number	Signal
2	TXD	2	RXD
3	RXD	3	TXD
5	GND	5	GND

2-wire RS485 pinout

Signal	Pin number	Signal
A (TX+ / RX+)	1	TX+
B (TX- / RX-)	4	RX+
GND	5	GND and Shield
	8	TX-
	9	RX-

4-wire RS485 pinout

Pin number	Signal	Pin number	Signal
YELLOW	RX+	1	TX+
GREEN	TX+	4	RX+
BLACK	GND	5	GND and Shield
WHITE	RX-	8	TX-
BLUE	TX-	9	RX-

ATTENTION ATTENTION: DB9 port

- The 4.3" models have only one DB9 port that supports RS232 and RS422 / RS485 signal levels on different pins.
- If user wants to connect different devices on RS232 and RS422 / RS485 levels, simultaneously with 4.3" HMI, then he must use 'Y' type cable.

Ethernet Port

FP2 series support Ethernet port as an ordering option. It's having standard shielded RJ45 female jack with built-in speed and indication LED'S.

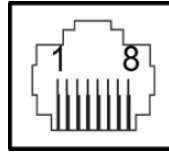

Pin number	Signal
1	TX+
2	TX-
3	RX+
4	NC
5	NC
6	RX-
7	NC
8	NC

USB Device Port

FP4 products support one MicroUSB port for programming and monitoring.

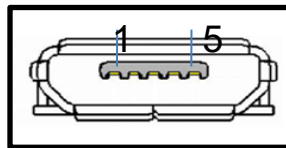

Pin number	Signal
1	VCC
2	D-
3	D+
4	NC
5	GND

USB Host Port

FP4 products support one USB Host port that connects to USB 2.0 compatible pen drives. The pen drive can be used as external memory for data logging and transferring user application or firmware to the unit.

Pin number	Signal
1	VCC
2	D-
3	D+
4	GND

Y Type Cable

Special “Y” cable for FP unit (two communication levels on one port).

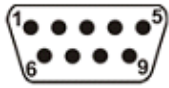
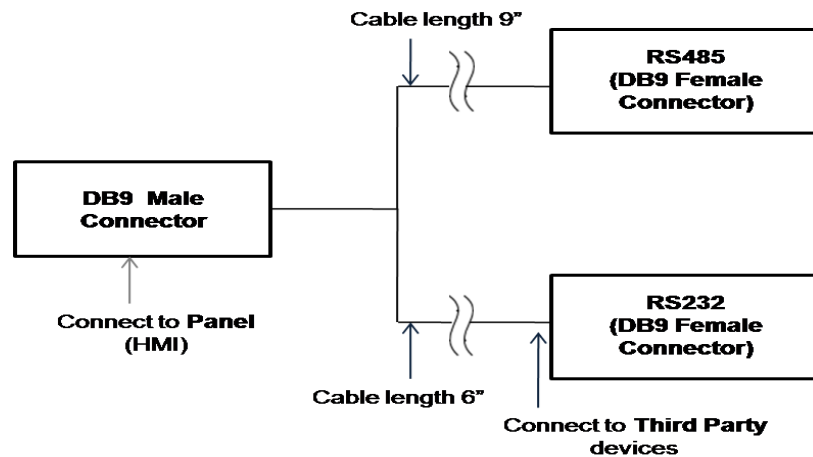

(DB9 Male connector)

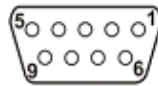

(RS485 Female connector)

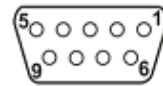

(RS232 Female connector)

Pin number	Signal	Pin number(RS485)	Pin number(RS232)
1	TX+	1	1
2	TXD	2	2
3	RXD	3	3
4	RX+	4	4
5	GND	5	5
6	NC	6	6
7	NC	7	7
8	TX-	8	8
9	RX-	9	9

SD Card Slot

Ethernet models of FP4 products support one SD card slot. SD card can be used as external memory for data logging and transferring user application or firmware to the unit. MicroSD HC card with capacity between 4 GB to 32 GB is supported.

Following speed classes are supported:



Accessories:

Programming Cable (Download) Micro USB

Part number: PC-USBAB-00-Micro

[Note: PC-USBAB-00: 2M cable, PC-USBAB-05: 5M cable, PC-USBAB-10: 10M cable]

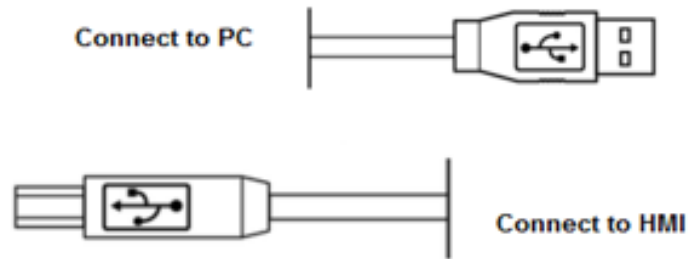

Communication Cable RS-232

Part number: IBM0909-1-00

[Note: IBM0909-1-00: 2M cable, IBM0909-1-05: 5M cable, IBM0909-1-10: 10M cable]

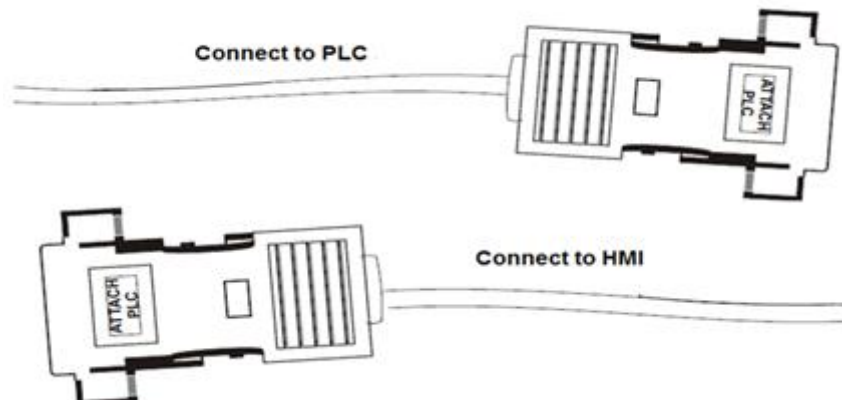

Environmental Specifications and Approvals

Feature	Specifications
Operating Temperature	-10° to 60° C
Storage Temperature	-20° to 85° C
Relative Humidity	10 to 95% non-condensing
Shock	IEC 60068-2-27 25g, 11ms, 6 shocks per axis, total 18 shocks (X, Y, Z)
Vibration	IEC 60068-2-6 5 to 150 Hz, 3g peak (X, Y, Z)
EMC	EN 55011:2009/A1:2010 EN 61131-2:2007 EN 61000-6-2:2005/AC:2005 EN 61000-6-4: 2007/A1:2011
Protection	IP 66 for front panel mounting
CE	Yes
UL	Yes (Class I Division 2)
RoHS	Yes

[Note: For UL Operating Temperature range is 0-50°C]

Revision History

Revision	Description	Date	Prepared by	Approved by
1.0	First Draft	25/07/2018	PM	AR

Renu Electronics reserves the right to change or discontinue specifications and features without prior notice.

NOTES