

## Flexible PLC Salient Features :-

- DIN rail / Back panel mounted compact PLC
- Up-to 2 Serial Ports , 1 USB Device Port ,1 USB Host Port
- One Ethernet port to connect PLC / Programming Port / Remote monitoring over Modbus TCP/IP
- Expandable up to 16 expansions
- 32 Bit RISC processor
- Simple Ladder programming using Windows® based software
- Support for LD, FBD, ST, SFC, IL type IEC61131-3 programming languages
- Support for web server functionality
- Strong Communication capabilities. PLC can be configured as Modbus RTU Master or Slave
- DC powered units (24 V DC)
- CE, UL approved

# Key Features :-

The FL100 support standard Programmable Logic Controller features. The user can implement logic, specific to application using standard Ladder programming. A PLC logic block can be executed at power up, during every scan, upon a timer interrupt.

Supported Tasks include:

- Write value to Tag
- Subtract a constant value from Tag
- Subtract Tag B to Tag A
- Turn Bit Off
- Copy Tag B to Tag A
- Add a constant value to Tag
- Add Tag B to Tag A
- Turn Bit On
- Toggle Bit
- Swap Tag A and Tag B

The FL100 possess powerful programmable logic features. User can implement logic, specific to application using standard Ladder programming. Some of the Key features are as mentioned below :

## Expansion module (Digital and Analog)

FL100 can be expanded using modular I/O modules. These modular I/O are Digital and Analog type. User can use Digital / Analog or combination of both. Various combination of Digital expansion modules are available. User can have up to 4 universal analog inputs and 2 analog outputs or 8 analog inputs. Analog inputs are mA, mV, 0-10 VDC, RTD and TC. The Analog outputs are 4-20 mA or 0-10 VDC. User can select appropriate I/O module depending on the application.

## Communication

The PLC is designed to have up-to 2 serial and 1 USB communication ports. Serial ports can be defined as Modbus RTU (Master or Slave) or can be connected to various third party devices such as PLCs, Drives, PID Controllers, SCADA etc. Most industry standard protocols are supported. The USB port is used for programming and monitoring the PLC.

## Ethernet Port

FL100 supports Ethernet port. It can be used to connect to a PLC and monitor machine / process status from remote location. The Ethernet port can also be used for remote programming of FL100.

## USB Ports

It has one USB (Device) port. The USB port can be used as a programming port or for logic monitoring. The unit also has one USB (Host) port. The USB Host port can be used to connect a memory drive.

## Web Server

FL100 supports web server functionality. It can be used to monitor and control from remote locations. Following are the features of the web server:

- i) User can create up to 100 Web screens in a project.
- ii) User can use up to 100 tags in a Web screen.
- iii) Up-to 10 users can make active connection with web server at any instance.
- iv) Fast data refresh (1 sec)
- v) Supports Data Entry, Data Display, Images, Multilingual text and Navigation buttons.

## FL100 Functionality

Some of the supported Instructions in FL100 are listed below :

### 1. Math

Instructions such as ADD, Subtract, Multiply and Divide. These instructions could be Single word or Double word, signed or unsigned format.

### 2. Data compare

Instructions such as Less than, Greater than, Equal to, Less than or Equal to, Greater than or Equal to etc. are supported.

### 3. Data Transfer Instructions

Data transfer instruction supports word and double word operands, Multiplexer / demultiplexer instructions.

### 4. Data conversion

Data conversion such as hex to ASCII, ASCII to hex, Binary, BCD, 2's Compliment, 7 segment etc. are possible.

### 5. Shift / Rotate

Rotate left, Rotate Right, Shift Left, Shift Right for word / double word.

### 6. I/O Instructions

Normally Open / Normally Closed contacts, positive pulse contact, negative pulse contact, Leading / Falling edge etc. are implemented.

### 7. Immediate I/O instruction

This instruction can be used to sample instantaneous physical inputs and outputs in PLC ladder.

### 8. Set / Reset

Coil / Bit / Register Set / Reset Instructions are supported.

### 9. Program Control

FL100 also support subroutine call, MCS / MCR, JCS / JCR, Enable / Disable Interrupts and step sequence instructions.

### 10. Functions

The function instructions like Moving average, Digital filter, Function generator, PID, Encode / Decode, Min / Max / Average Value, Lower / Upper Limit, Flip Flop are also supported.

Comprehensive Instructions supported in FL100 :

I/O Instructions - NO contact Falling Edge Inverter Coil Positive pulse coil	NC contact Rising Edge Positive Pulse Contact Negative Pulse Coil	Output Inverter Negative Pulse Contact
Data Transfer - MOV word Table Initialize Data Exchange	MOV DWORD Table Block Transfer Multiplexer	Invert Transfer Table Invert Transfer Demultiplexer
Math- Addition Division Increment	Subtraction Addition with Carry Decrement	Multiplication Subtraction with Carry
Compare - Greater than Not Equal	Greater than or equal Less Than	Equal Less than or Equal
Logic - AND Shift	OR Rotate	XOR
Data Conversion - Hex to Ascii 7 segment decode BCD conversion	Ascii to Hex Ascii conversion 2's complement word 2's complement Double word	Absolute Value Binary Conversion
Timer - TON	TOFF	TSS
Counter- Up counter	UP Down Counter	
Program Control - Subroutine CALL Next Jump Control Set Dis Intr Step sequence Input	Subroutine RET Master Control Set Jump Control Reset WTR Step sequence output	For Master Control Reset En Intr Step sequence Init
Function - Moving Average Upper limit Minimum Value	Digital Filter Lower limit Average Value	PID1,4 Maximum Value Function generator
Special - Device Set Register Reset Encode Decode Direct I/O	Device Reset Set Carry Bit Count Set Calender	Register Set Reset Carry Flip Flop Calender Operation

## Configuration Software

FlexiSoft® is a compact, Windows® based software to configure the PLC. Following image from FlexiSoft® shows the snap shot of ladder configuration window:

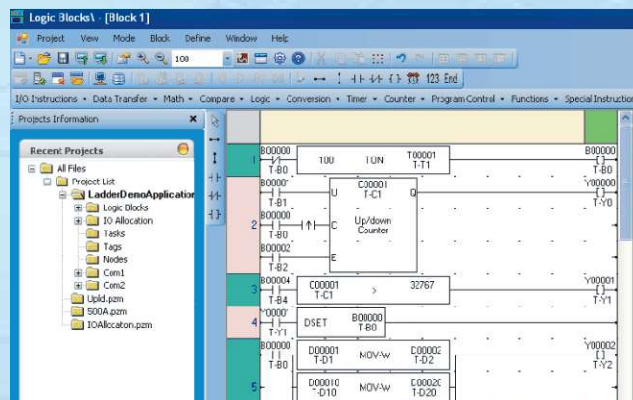

System requirements for FlexiSoft® Software are -

Windows Version	: Microsoft Windows® 2000 or above
Processor	: 266 MHz PENTIUM or higher
Mouse	: Required
RAM	: 64 MB or more
Display resolution	: 800 x 600 (VGA) or better
Display colors	: 256 colors minimum
Serial Port	: 1 serial port for FlexiPanels® programming
USB Port	: 1 USB port (Host) for FlexiPanels® programming
Keyboard	: Required



# Software Features :-

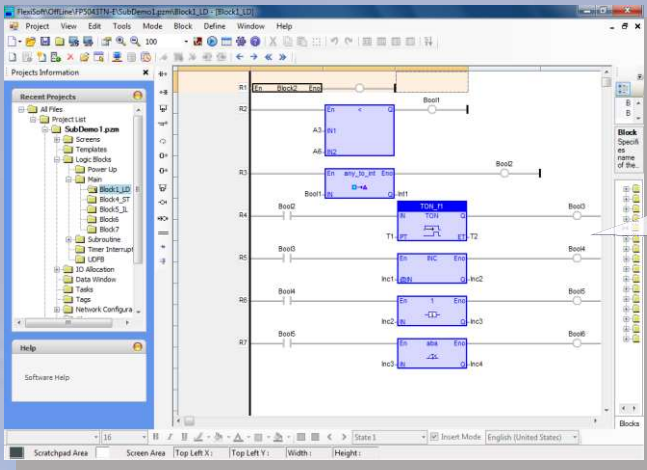

IEC61131-3 Programming Environment  
Create application using LD language

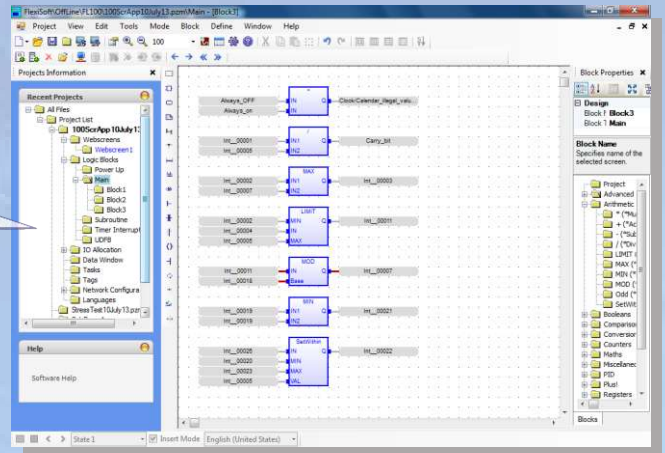

IEC61131-3 Programming Environment  
Create application using FBD language

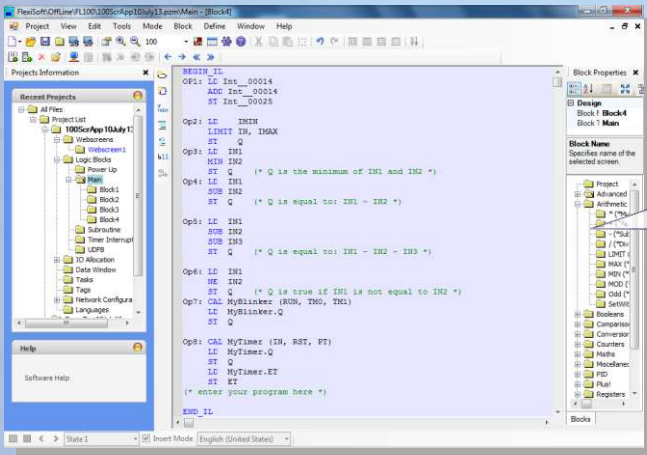

IEC61131-3 Programming Environment  
Create application using IL language

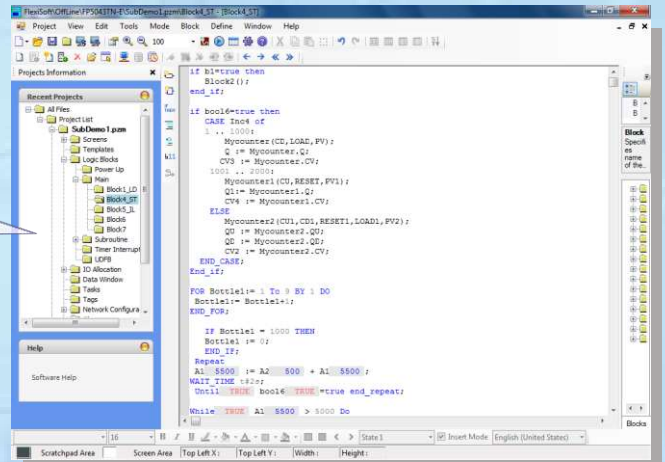

IEC61131-3 Programming Environment  
Create application using ST language

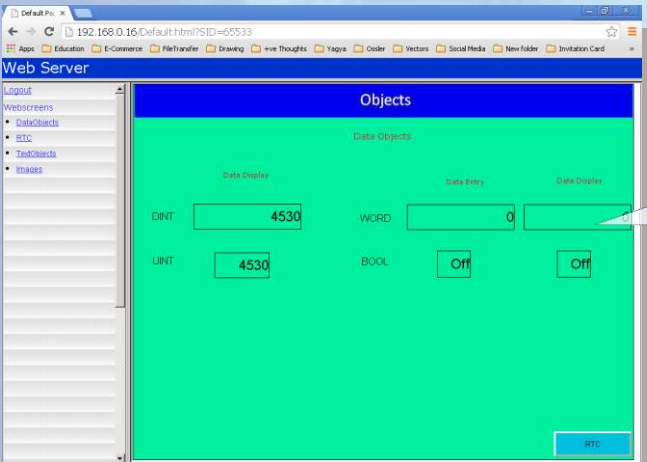

Web Server functionality  
FlexiSoft® now supports powerful and user friendly Web server functionality. It allows user to monitor and control from remote locations.

## Protocols Supported for :-

Driver	FL100
ABB	✓
Allen Bradley DF1	✓
Aromat FP Series	✓
Baldor	✓
Danfoss Drive	✓
Delta	✓
Fatek	✓
G9SP Safety Controller*	✓
GE Fanuc	✓
GE SNP-X	✓
Idec	✓
Logix 5000 PLCs*	✓
LG Master K series PLC	✓
LG Master-K 300S	✓

Driver	FL100
Mitsubishi Q Series PLC	✓
Mitsubishi FX	✓
Modbus Master	✓
Modbus Slave	✓
Modbus TCP Master	✓
Modbus TCP Server	✓
Serial Monitor	✓
Toshiba Inverters	✓
Toshiba Ethernet Driver*	✓
Toshiba T1	✓
Toshiba T2 Link port	✓
Twido	✓
Unitelway	✓
Universal Serial (ASCII)	✓

\*Coming Soon

## Specifications :-

Functional	
Control Method	Stored program cyclic scan system
I/O Processing	Batch I/O update(refresh) and Direct I/O access
I/O Points	Expansion I/O: Up to 16 I/O modules, Expandable up to 256 points
Programming Language	Ladder diagram / IEC 61131-3
Program Capacity	5120K Steps
Memory	Program: Flash Type Data: DDR2 RAM and EEPROM
Execution Speed	20.43 ns/contact 81.72 ns/coil 127.12 ns / 16-bit transfer 124.85 ns /16-bit signed addition

User Data	
Timer Registers	256 Words (R/W)
Counter Registers	256 Words (R/W)
System Registers	256 Words (R/W)
Internal Registers	256 Words (R/W)
Data Registers	4096 Words (R/W)
Input Registers	400 Words (Max) (R)
Output Registers	400 Words (Max)
Configuration Regs.	1600 Words (Max)
Configuration Coils	25600 Points (Max)
System Coils	100 Points (R/W)
Internal Coils	4096 Points (R/W)
Timer Coils	256 Points
Counter Coils	256 Points
Retentive Registers	1400 Words

Clock-Calendar	Year, month, day, hour, minute, second, & day of the week
Timer	256 timers T0000 to T0255 T0000 to T0060: 10ms T0061 to T0190: 100ms T0191 to T0255: 1s
Communication Interface	1 Port of RS232/RS485 on RJ45 1 Port with 2-wire RS 485 on Terminal Block 1 USB Port for Programming and monitoring (Device) 1 USB (host) port to connect USB memory drive 1 Ethernet port to connect PLC/ Programming Port
Electrical	
Power Supply	DC powered units - 24VDC (+/-15%)

Environmental	
Temperature	-20 to 60° C (operating), -20 to 85° C (storage)
Humidity	10 to 90 % non condensing
Vibration immunity	IEC60068-2-6
Shock immunity	IEC60068-2-27
Dimensions (mm)	100mm(H) X 36mm(W) X 70mm(D)
Isolation	Isolation between communication ports, power and I/O is 500 V DC for 1 Min.
EMI/EMC	
Immunity to ESD	as per IEC61000-4-2
Immunity to Fast Transients	as per IEC61000-4-4
Immunity to Radiated Electromagnetic field	as per IEC61000-4-3
Immunity to Conducted disturbances	as per IEC61000-4-6
Surge	as per IEC61000-4-5
Radiated emission	as per EN55011

# Specifications :-

Hardware Specifications	
Processor	32 bit RISC Processor (400MHz)
Power Supply	Input Voltage 24VDC
	Tolerance $\pm 15\%$
	Reverse polarity protection YES
Communication ports	2 Serial ports COM1 : RS232/ RS422/RS485 2 and 4 wire. RJ45 Connector COM2 : 2 Wire RS485. 4 pin PBT connector
	1 Ethernet port 10/100 Mbps
	1 USB HOST port For connecting USB Memory Drive
	1 USB Device port For Upload, Download and monitoring
	1 Expansion Connection Slot 16 expansion modules / 256 I/O points
Switches	PLC mode Control Switch RUN/HALT
Memory	User Application 22MB
	Ladder 30MB
	Retentive 1400 words
	Keep memory Area 1000 words
RTC	Type External
Operating temperature	-20 to 60° C
Storage temperature	-20 to 85° C
Humidity	10% to 90% (non condensing)
Approvals	CE, UL (Class 1 Div 2), RoHS

Functional Specifications			
Communication	2 serial ports	COM1 : RS232/ RS422/RS485 2 and 4 wire.	Upload, Download, Monitoring and Serial communication
		COM2 : 2 Wire RS485	2 Wire RS485 Communication
	1 Ethernet	10/100 Mbps	Upload, Download, Monitoring and Ethernet communication
	1 USB HOST port	All Standard Brand's USB Sticks	Upload, Download
	1 USB Device		Upload, Download and Monitoring
	Expansion	SPI	16 Slots (All FL Expansions)
	Multinode	Serial : 32 nodes Ethernet : 256 nodes	

## Digital I/O Specifications : Analog I/O Specifications :

Expansion I/O Capacity	16 expansion modules
Expansion Bus	SPI
Turn ON time	10 msec
Turn OFF time	10 msec

For mV inputs :
Uses 0-100 mV input range resolved in 16 bits. Total error max : $\pm 0.2\%$ of scale $\pm 1$ LSB.
For Current inputs :
Uses 0-20mA input range is resolved in 16 bits. Total error max : $\pm 0.2\%$ of scale $\pm 1$ LSB.
For Volt inputs :
Uses 0-10V input range resolved in 16 bits. Total error max : $\pm 0.2\%$ of scale $\pm 1$ LSB.
For RTD input (Pt100/ Pt1000):
Uses 3 wire compensation technique. Excitation Current is 0.1mA. Power dissipated in RTD is 0.025mW max @ 100 $\Omega$ Range supported : -200 to 850°C.
For Thermocouple Input :
Uses 0-100mV input range resolved into 16 bits. Cold junction error is 1° maximum and 0.5° typical. Total error max : 0.5% of scale $\pm 1$ bit + CJC error Temperature Drift for Input and Output : 60 PPM max

Input Type	Temperature Range	1 Bit Corresponds to
J	-210 to 1200°C	0.035°C
K	-200 to 1373°C	0.049°C
E	-200 to 1000°C	0.027°C
R	-50 to 1769°C	0.16°C
S	-50 to 1769°C	0.18°C
B	0 to 1820°C	0.25°C
N	-200 to 1300°C	0.056°C
T	-200 to 400°C	0.043°C

Analog Outputs	
Resolution	16 Bit
Load:	
4-20 mA	Less than 500 $\Omega$
0-10 V DC	Minimum 1k $\Omega$

# Expansion Modules :-

## Digital Expansion Modules

Model	Digital I/P	Digital O/P	Details
FLD1600	16	0	16 Digital Inputs
FLD0016P	0	16	16 Digital Outputs (PNP)
FLD0016N	0	16	16 Digital Outputs (NPN)
FLD0016R	0	16	16 Digital Outputs (Relay)
FLD0808P	8	8	8 Digital Inputs, 8 PNP type Transistor Outputs Digital module
FLD0808N	8	8	8 Digital Inputs, 8 NPN type Transistor Outputs Digital module
FLD0808R	8	8	8 Digital Inputs, 8 Relay type Outputs Digital module
FLD-HS-0808P	8	8	8 Digital Inputs, 8 Digital Outputs (PNP), 4 High Speed Inputs (Single phase & Quadrature counter), 2 PWM Outputs
FLD-HS-0808N	8	8	8 Digital Inputs, 8 Digital Outputs (NPN), 4 High Speed Inputs (Single phase & Quadrature counter), 2 PWM Outputs

## Analog Expansion Modules

Model	Analog I/P	Analog O/P	Details
FLA0800L	8	0	8 Analog Inputs (0-10 VDC / 4-20 mA), 16 Bits
FLA0402U	4	2	4 Universal Inputs (0-10 V / 0-100 mV / 0-50 mV / 0-20 mA / 4-20 mA / RTD PT-100 / Thermocouple - B, R, S, E, J, K, N, T)
FLA0004	0	4	2 Analog Outputs (0-10 V / 4-20mA), 16 Bits 4 Analog Outputs (0-10 VDC / 4-20 mA), 16 Bits

N: Transistor output (NPN 500mA), R: Relay O/P, (6 Relay + 2 OC) P: PNP output (500mA)

## Dimensions :-

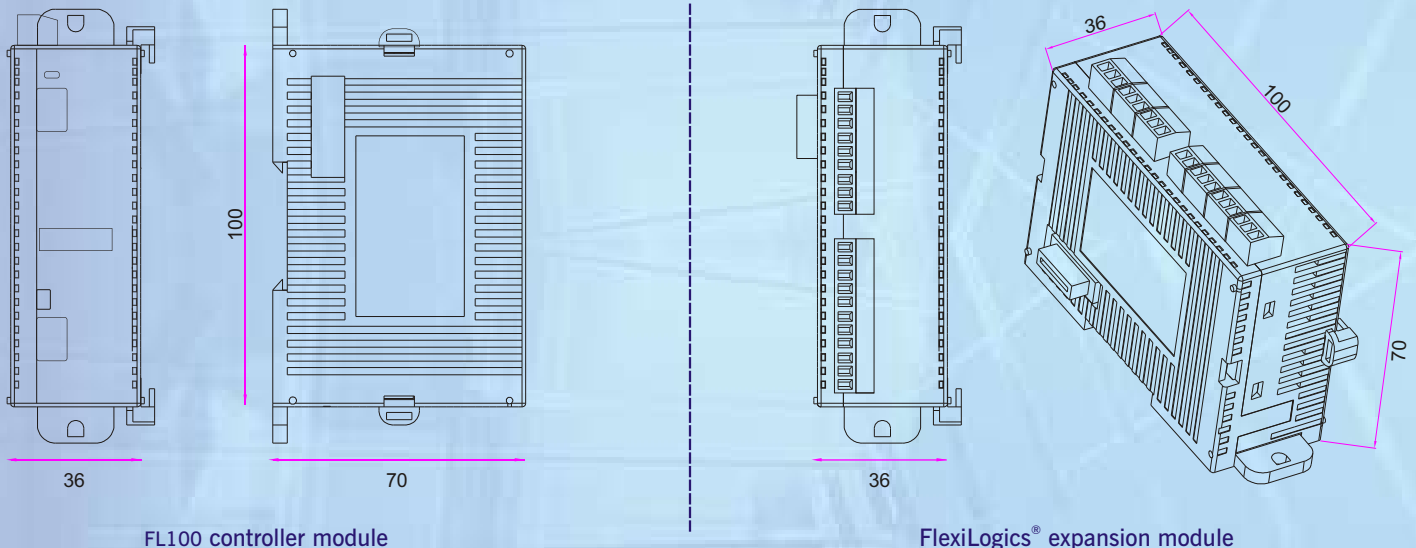

All dimensions are in mm.

Please contact factory for more information. We welcome an opportunity to develop new, custom drivers and customized units.



### HEAD OFFICE

Survey No. 2/6, Baner Road, Pune - 411045, India.

Tel : +91 20 2729 2840 Fax : +91 20 2729 2839

Email : [info@renuelectronics.com](mailto:info@renuelectronics.com)

Website: [www.renuelectronics.com](http://www.renuelectronics.com)

An ISO 9001:2008 and ISO 14001:2004 certified company